



RUINI GROUP

Per chi punta **in alto.**



Concessionario:



HUBTEX.

DANTHERM GROUP

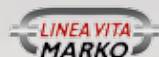

NOLEGGIO e VENDITA

n. 55

AUTOCARRATE OMOLOGATE PER SBARCO IN QUOTA DALLA CESTA



**PIATTAFORMA CINGOLATA
ARTICOLATA
AUTOLIVELLANTE**



PANTOGRAFI

ELETTRICHE

M 6-8-10-12-14-16-18-22
AL LAVORO

DIESEL

M 12-14-16-18-19-26
AL LAVORO



**PIATTAFORMA CINGOLATA
AUTOLIVELLANTE
M 10 AL LAVORO**



**PIATTAFORMA
A SPINTA**

**PIATTAFORMA
DA INTERNI
CON PIANALE
PER CARTONGESSO**



SEMOVENTI ELETTRICHE
M 12-15-16-18-21 AL LAVORO

SEMOVENTI DIESEL
M 16-18-21-23-26-32-41
AL LAVORO

SEMOVENTI IBRIDE
M 18-20 AL LAVORO



RAGNO

M 13-14-15-36

M 15 CON GANCIO

M 17-18-20-22-27

M 22-27-42
CON ARGANO

AUTOCARRATE OMOLOGATE PER SBARCO IN QUOTA DALLA CESTA

M 14 PATENTE B SU PICK UP

M 20 PATENTE B CON GANCIO

M 21 PATENTE B CON GANCIO

M 22 PATENTE B

M 24 PATENTE B

M 25 PATENTE B

M 27 PATENTE C

M 28 PATENTE B

M 28 PATENTE C

M 32 CON OPERATORE

M 35 CON OPERATORE

M 37 CON OPERATORE

M 47 CON OPERATORE

M 54 CON OPERATORE





**SCALA TRASLOCHI
SU CAMIONCINO
ALTEZZA 21 M E 30 M**



TRABATTELLO



**SCALA
TRASLOCHI
PORTATA
200 KG
FINO A 20 M**



ALTEZZA 18 M



SCALA CON GABBIA



**SCALA TELESCOPICA
MULTIPOSIZIONE**



**PIATTAFORMA
PER USO INTERNO
ED ESTERNO**

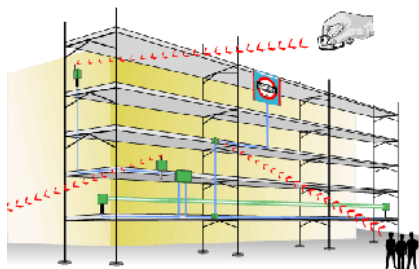

**NOLEGGIO PONTEGGI
POSSIBILITÀ DI INTALLAZIONE
ALLARME ANTIFURTO**

PONTEGGIO A 2 COLONNE

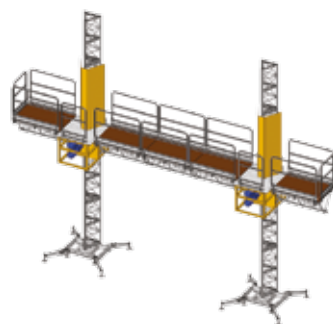

**TRABATTELLO
PROFESSIONALE
DA 1,70 M
FINO A 14 M**

PUNTELLI



**MONTACARICHI
A COLONNA**





CARRELLI RETRATTILI

Concessionario di Zona



**CARRELLI ELEVATORI ELETTRICI | DIESEL
FINO A 100 Q.LI**



**CARRELLI TELESCOPICI
FISSI E ROTATIVI
CESTA CON SBARCO**

**CARRELLO TELESCOPICO
ELETTRICO
6 - 26 M**



AISLE-MASTER



**CARRELLI ELEVATORI
MULTIDIREZIONALI**



**CARRELLO ELEVATORE
MULTIDIREZIONALE
PORTATA 30 - 40 Q.LI | DIESEL | ELETTRICI**



**SOLLEVATORE
PER VETRI**

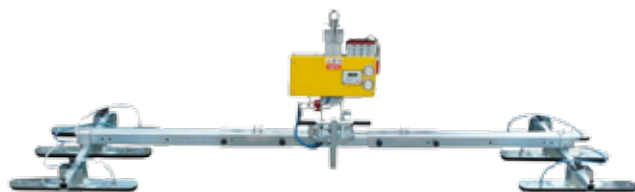

VENTOSA PER PANNELLI SANDWICH



GRUETTA MANUALE



VENTOSA PER VETRI

- PORTATA 400 KG
- PORTATA 600 KG
- A 2 PIASTRE
PORTATA 200 KG
- VENTOSA
RADIOCOMANDATA
PORTATA 800 KG



**MANIPOLATORE PER VETRI
FINO A 420 KG**



MULTI-LOADER ML 3.0 FX



**MINIGRU CINGOLATA
250 | 360 | 400 | 500**



GRU SEMOVENTE ELETTRICA

- PORTATA 0.60 T
- PORTATA 2 T
- PORTATA 3.2 T
- PORTATA 4.5 T
- PORTATA 8 T
- PORTATA 10 T
- PORTATA 13 T
- PORTATA 25 T



RAMPE DA CONTAINER



**CESTA PORTA
PERSONE
APPLICABILE A
CARRELLI ELEVATORI**



**SALISCALE
ELETTRICO**



**SOLLEVATORE
MANUALE
A M 4 DI ALTEZZA
PORTATA 250 KG
A M 7,20 M DI ALTEZZA
PORTATA 250 KG**



PIATTAFORMA ELETTRICA



**PATTINI A RULLI
CARROARMATO**



SOLLEVATORE PER CARTONGESSO



TRANSPALLET



**TRANSPALLET
ELETTRICI**



**TRANSPALLET
CON PESA**



FORCHE RIBASSATE



**TRANSPALLET
ELETTRICI A COLONNA**



**TRANSPALLET
PER SUOLI DISCONNESSI**



BILANCINO



**TRANSPALLET
MANUALE ELETTRICO**

CAMION GRU NOLO A FREDDO

16 M - PATENTE B
21 M - PATENTE C



CAMION

- PATENTE B/C PORTATA 60 Q.LI
- CAMION FISSO
- CAMION RIBALTABILE
- CAMION CON GRU



CAMION GRU CON OPERATORE

28 M - 36 M - 40 M



AUTOGRU

100 - 200 Ton



AUTOGRU

FINO A 180 Ton

VEICOLI COMMERCIALI



PUNTO



PANDA

AUTO A NOLEGGIO



AUTOCARRI CON CASSONE



PER OGNI ESIGENZA



PULMINO 9 POSTI



CENTINATI



**CARRO ATTREZZI
PATENTE B/C**



LAVASCIUGA PAVIMENTI



ASPIRATORE E ASPIRA LIQUIDI

MOTOSCOPA
UOMO A BORDOIDROPULTRICE
ELETTRICA / SCOPPIOMOTOSCOPA
UOMO A TERRA



**BENNA
MORDENTE**

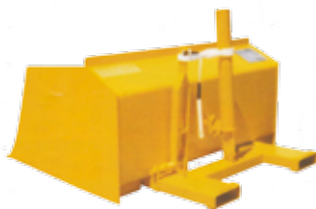

**BENNA
ROVESCIBILE**



**PINZA PER
PANNELLI VERTICALI**



**PINZA
MORDENTE**



**FORCA
PER TUBI**



**FORCA PRENSILE
PER MINIPALA
(CAMS 755 E BOBCAT S100)**



**SPARGISALE
SPARGICONCIME
SPARGISABBIA**



**CANNONE
PER LE POLVERI**

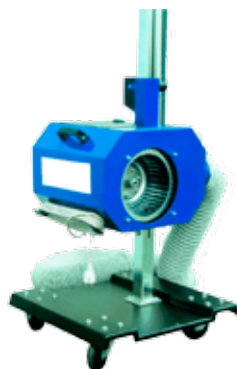

ASPIRAFUMI



10 Q.LI - 12 Q.LI
10 Q.LI - 12 Q.LI A BATTERIA
 14 Q.LI - 15 Q.LI - 16 Q.LI
 17 Q.LI - 18 Q.LI
 25 Q.LI - 30 Q.LI
 35 Q.LI - 50 Q.LI - 85 Q.LI



MINI ESCAVATORI



MINI PALA
 12 - 18 - 25 - 28 Q.LI

**MINI PALA
 CINGOLATA**
 25 - 38 Q.LI



AUTOBETONIERA



RULLO COMPATTATORE
 18 - 30 - 40 Q.LI



**CONTENITORE GASOLIO
 PORTATILE**



**TRINCIA
PER ESCAVATORI**



**BENNA
FRANTOIO**



**PALA GOMMATA
75 Q.LI - 75 CV - 1.5 MQ DI PALA**



PIANTA PALI



**MOTOCARRIOLA
AUTOCARICANTE**



FRESA PER ASFALTO



**MOTOCARRIOLA
CINGOLATA
RADIOCOMANDATA
A BATTERIA**



**ACCESSORI MARTELLO E TRIVELLA
PER MINI ESCAVATORI**



**PINZA
FRANTUMATRICE
PER 85 Q.LI**

**CALDAIA SCALDA MASSETTI****IMPIANTO DI RISCALDAMENTO****RISCALDATORE ELETTRICO
AD INFRAROSSI
1,5 KW****STUFA A RAGGI INFRAROSSI A BATTERIA****GENERATORE MOBILE DI CALORE****STUFE ELETTRICHE**



TERMODISINFESTAZIONE
DISINFESTAZIONE DEGLI
INSETTI E DISINFEZIONE
CON IL CALORE



VENTILATORE

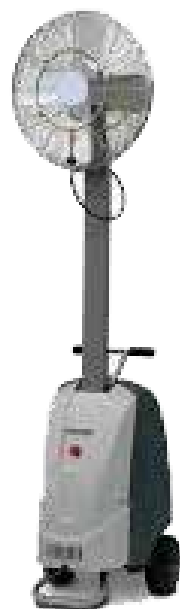

**VENTILATORE
NEBULIZZATORE**



DEUMIDIFICATORE



**CONDIZIONATORE
E DEUMIDIFICATORE
PORTATILE**



**RAFFRESCATORE
PORTATILE**



MOLA CON PIEDISTALLO



SALDATRICE A FILO

**BARRIERE ANTITERRORISMO**

UN BLOCCO MISURA 180 X 60 X 60 CM - PESO 15 Q.LI



DIMA
PER SEGNALETICA
STRADALE

**CARTELLI SEGNALETICI**

CONO TELESCOPICO
DA 5 CM PIEGATO
70 CM DI ALTEZZA
PESO 2 KG



TRACCIALINEE
PER CAMPI SPORTIVI

**SEMAFORO A LED****MINI TRACCIALINEE**



**REALIZZAZIONE SEGNALETICA
STRADALE E SEGNALETICA INTERNA**



NASTRO RETRATTILE



CONTAINER



WC CHIMICO



BOX CONTAINER CON QUALSIASI TIPO DI MODIFICA



ESTINTORI



GAZEBO PORTATILI PER EVENTI
 MONTAGGIO RAPIDO SENZA ATTREZZI
 MINIMO INGOMBRO NEL TRASPORTO
 3 X 3 M
 3 X 6 M



PORTONI AD IMPACCHETTAMENTO



PAGODA



**HANGAR PER
 RIMESSAGGIO
 AUTOMEZZI
 O FORAGGI**

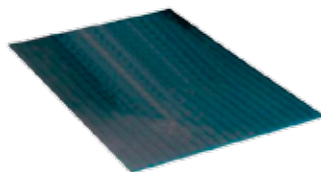

PAVIMENTO IN PLASTICA

**TUNNEL DI
 RICARICO
 4 X 4 M**

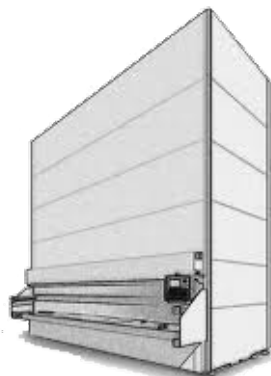

MAGAZZINI AUTOMATICI



TORRE FARO



**TORRE FARO
CON GENERATORE**



**TORRE FARO
DI EMERGENZA**



**QUADRI
ELETTRICI
PORTATILI
PER CANTIERE**



GENERATORI



**GRUPPI
ELETTOGENI**



**FARO PER
ILLUMINAZIONE
ESTERNA AL LED**



**FARO
PORTATILE
AL LED**

CE  IP54  



**TUBO
PER SCARICO DETRITI**



**CASSERI
PER PILASTRI**



**BARRIERE MOBILI
RAPID ROLL**

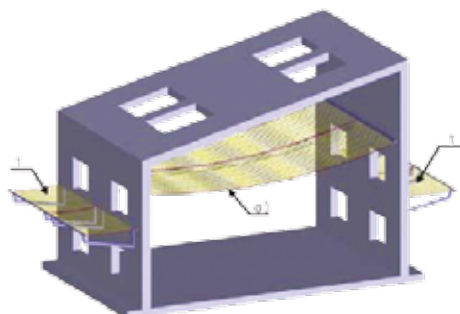

RETE ANTICADUTA



**TRANSENNE IN FERRO
E IN PLASTICA**



PROTEZIONI PER PEDONI



**RAMPA DI CARICO
CON BORDO**



**ARROTOLATORE
ANTICADUTA**



PANNELLI DA CANTIERE



**GRU EDILE
DI QUALSIASI ALTEZZA**



RECINZIONE 4 TUBI



**BASE DI
APPOGGIO**



PLINTI ABS

ATTREZZATURA LINEA VITA CERTIFICATE UNI EN 795

**SISTEMI ANTICADUTA DALL'ALTO A NORMA
PER SICUREZZA TETTI E COPERTURE**

LINEA VITA

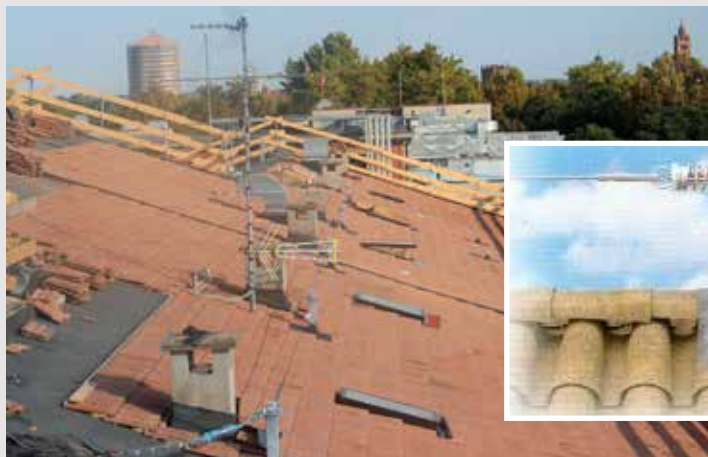

TORRETTE



KIT IMPERMEABILIZZAZIONE



ATTREZZATURA LINEA VITA CERTIFICATE UNI EN 795

KIT LINEA VITA RAPID



SCALA A GABBIA



ANCORAGGI



ACCESSORI



elemento di partenza



elemento intermedio



rialzo h 47mm



rialzo h 35mm



rinvio d'angolo



staffa a "L"



contropiastra

ATTREZZATURA LINEA VITA CERTIFICATE UNI EN 795

PARAPETTI

SISTEMI DI PROTEZIONE BORDI PROVVISORI
E PERMANENTI

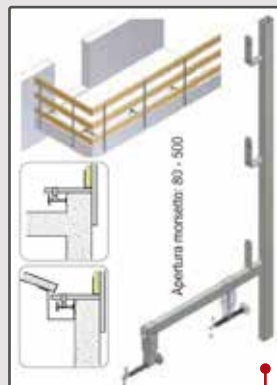

114F
Parapetto registrabile
per cordoli 8-50

PARAPETTI PERMANENTI



103
Parapetto
universale
con bascula

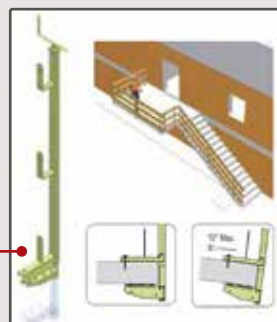

113B
Parapetto
inclinabile
per calcestruzzo

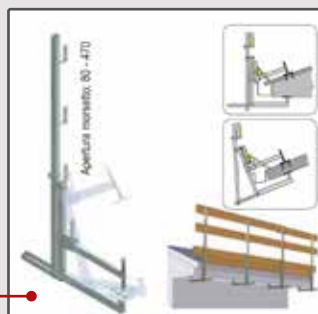

ATTREZZATURA LINEA VITA CERTIFICATE UNI EN 795

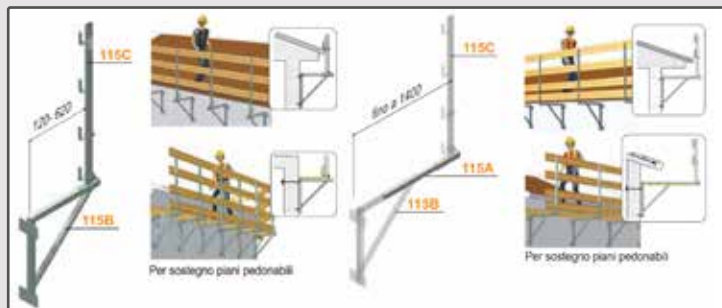

115BC
Parapetto a mensola
12-62 + 115A
prolunga per apertura
fino a 140

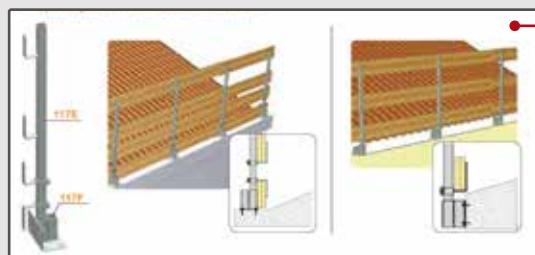

117G
Parapetto per bordi
orizzontali e verticali

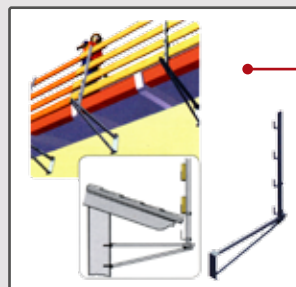

115MP
Parapetto a mensola 13-110



116
Parapetto sottotegola

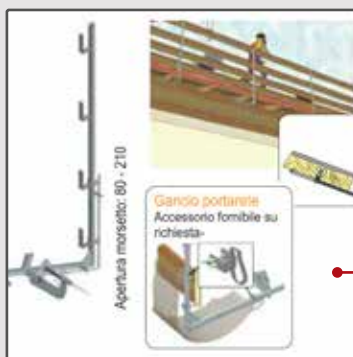

112FR
Parapetto frontale
per legno

ATTREZZATURA LINEA VITA CERTIFICATE UNI EN 795

LINEE VITA SU COPERTURE METALLICHE

SERIE DAYTONA



SERIE 1000MIGLIA RK

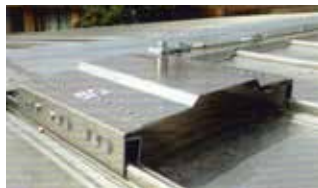

SERIE 1000MIGLIA

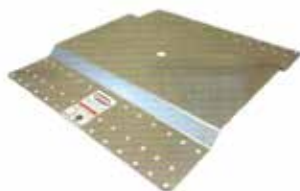

SERIE DAYTONA-A



SERIE 1000MIGLIA RK-A



SERIE STEYR

PUNTO DI ANCORAGGIO
IN SPAZI CONFINATI

SERIE C.E.K. LINE





**MACCHINA PER PULIZIA
PANNELLI SOLARI**



**IDROPULTRICE
AD OSMOSI**



SPAZZOLA UNGER
UTILIZZABILE SIA PER PULIRE VETRI
CHE PANNELLI FOTOVOLTAICI,
SI ALLUNGA FINO A 8 M E PULISCE CON
SISTEMA DI OSMOSI INVERSA



ATTREZZATURA PER SMALTIMENTO AMIANTO**BOX ANTIDECONTAMINAZIONE
CON POMPA FILTRAZIONE ACQUE****POMPA PER FILTRAZIONE ACQUE****ESTRATTORE DI ARIA****ESTRATTORE D'ARIA
A FILTRO ASSOLUTO A 3 STADI****ASPIRAPOLVERE A
FILTRO ASSOLUTO
PER AMIANTO****INCAPSULANTE**



**SABBIATRICE
A GETTO LIBERO**



**SCANALATORE
PER MURO**



**FLESSIBILE
CON ATTACCO PER
ASPIRAPOLVERE**



**COMPRESSORE
ELETTRICO
ED A SCOPPIO**



MOTOCOMPRESSORE



**PIANTAPALI MANUALE
FINO A 130 MM**



**MESCOLATORE
MANUALE**



MOTOTRIVELLE



TRIVELLA CARELLATA



BETONIERA TRADIZIONALE

SOLLEVATORE
A BANDIERASEGA DA BANCO
TAGLIO ALT. 30 CM

TAGLIABLOCCHI

ELETTOSEGHE
A CATENA WIDIASEGA DA BANCO
PER PAVIMENTO
E LEGNOFILIERA
DA BANCO
MAX 3 POLLICI



POMPA PER TRAVASO



**POMPE A SPRUZZO
PER PITTURARE**



POMPA SOMMERSA



**MESCOLATORE
PROFESSIONALE**



**CAROTATORE MANUALE
PER LAVORI A SECCO
E AD ACQUA ANCHE CON
ASPIRAPOLVERE**



FRATTAZZATRICE



**CARTEGGIATRICE
A LUNGO RAGGIO
GIRAFFA**



INTONACATRICE



**TAGLIAPIASTRELLE
GRANDI FORMATI**



**TAGLIATUBI
DA 4 E 6 POLLICI**



TAGLIAPIASTRELLE



TAGLIACAPPOTTI



TOGLI MOQUETTE-PIASTRELLE



**MOTOTRONCATORI
A DISCO**



**SCARIFICATRICE
PER PAVIMENTI**



**LEVIGATRICE
CARRELLATA**



**COSTIPATORI
A PIASTRA**



**LISCIATRICI
DIAM. 60 - DIAM. 90**



VIBROCOSTIPATORI



**MARTELLI
PNEUMATICI**



**VIBROFINITRICI
PER CEMENTO**



**TAGLIASFALTO
BENZINA O ELETTRICA
PER ASFALTO
O CALCESTRUZZO**



**AVVITATORE
DINAMOMETRICO
A BATTERIA**



**TRAPANO
A BATTERIA**



**TRAPANO
A CALAMITA**



TASSELLATORE



PISTOLA SPARACHIODI



**CESOIA A BATTERIA
PER TONDINI DI FERRO
FINO A DIAM. 16**



TERMOCAMERA



VERRICELLO



VIBRATORE



LUCIDATRICE



SCARIFICATRICE MANUALE



FLESSIBILE A BATTERIA



**NASTRO
TRASPORTATORE
PER DETRITI**



ASPIRAFOGLIE DA SPONDA



SOFFIATORE DI FOGLIE E RIFIUTI



BIOTRITURATORE



ASPIRAFOGLIE CARRELLATA



MINI PELLETTATRICE



SPACCALEGNA



CARRIOLE PER IRRORAZIONE



MOTOPOMPE AUTOADESCANTI



TAGLIASIEPE A BRACCIO



MOTOSEGA A BATTERIA



**MOTOSEGA
A BATTERIA
PICCOLA**



DECESPUGLIATORE A BATTERIA



**SOFFIATORE
A BATTERIA**

IL TOSAERBA PROFESSIONALE DA PENDENZA FINO A 40°

TREMENDO

ENERGREEN
ILF S1500 - BRACCIO 12 MT



MINI ROBOGREEN



ROBOGREEN



TRINCIA LATERALE



TRATTORE CON LAMA DA NEVE



INTERRASASSI PER TRATTORE



TRINCIATORE GUARD-RAIL



MOTOCOLTIVATORE CON TRINCIA



SPAZZOLONE PER PULIZIA



FRESACEPPI PER ALBERI



INTERRAFILO



INTERRASASSI



MOTOCOLTIVATORI



MOTOZAPPA DA 50/80 CM



MOTOCOLTIVATORE IDRAULICO



SEMINATRICE



RULLO SEMOVENTE



SPANDISABBIA



FRESACEPPI



FRESACEPPI IDRAULICA SEMOVENTE



TRATTORINO



TRINCIATORE



CATENARIA



RULLO DA GIARDINO



**IRRORATRICE
PER TERRENI**



DECESPUGLIATORE CARELLATO



**TRATTORINO
SENZA RACCOLTA**



**TRATTORINO CON
TAGLIO FRONTALE
SENZA RACCOLTA**



TRATTORINO



**RASAERBA FRONTALE
A CARICO DIRETTO**



RASAEREBA



TRIVELLA
ORIZZONTALE PASSATUBI



RIGENERATRICE TRAZIONATA
PER CAMPI SPORTIVI



ELIMINA RODITORI



TAGLIAZOLLE



NEBULIZZATORE
ATOMIZZATORE



CAROTATRICI
A FUSTELLE VERTICALI



CAROTATRICI A TRAINO



PIROERBA A BRACCIO



PIRODISERBO SEMOVENTE
300 MQ ALL'ORA CON BOMBOLA
DA 15 KG / 5-6 ORE



**SPAZZOLA PER LA PULIZIA
DI CORDOLI E AUTOBLOCCANTI**



RIGENERATRICE



SPAZZOLATRICE A TRAINO



**ARIEGGIATORE A MOLLE O CON LAME
ANCHE CON RACCOLTA**



ARIEGGIATORE TRAZIONATO



SPANDISABBIA TRAINATO



**RIGENERATRICE AUTOMATICA
DI CAMPI DA TENNIS IN TERRA ROSSA**



**TRACCIALINEE
PER CAMPI SPORTIVI**



LE SEDI

SEDE CENTRALE ARCETO DI SCANDIANO

Via Borsellino, 11
Arceto di Scandiano (RE) | 42019
0522 989355 | 0522 980229
info@ruinimarco.it

FILIALE DI LUZZARA

Via Negre, 45 | Luzzara (RE) | 42045
335 5630451 | 0522 820560
luzzara@ruinimarco.it

FILIALE DI REGGIO EMILIA

Via Gramsci, 80/B | Reggio Emilia (RE) | 42124
345 9449404 | 348 2665321
reggioemilia@ruinimarco.it

FILIALE DI FIORANO MODENESE

Via Ghiarola Nuova, 110
Fiorano Modenese (MO) | 41042
331 6718559 | 0536 254066
fiorano@ruinimarco.it

FILIALE DI CARPI

Via Nuova Ponente, 38 | Carpi (MO) | 41012
392 9892974 | 340 7384857
carpi@ruinimarco.it

FILIALE DI MODENA

Via Vignolese, 1113/e | Modena (MO) | 41125
329 8813586 | 345 8321277
modena@ruinimarco.it

FILIALE DI BOLOGNA

Via Valtiera, 7/a | Calderara di Reno (BO) | 40012
334 7343571 | bologna@ruinimarco.it

NOLEGGIO e VENDITA
di macchinari e attrezzature per il
sollevamento, la movimentazione,
il trasporto, l'edilizia,
attrezzature per il verde e il
controllo della temperatura.



SEDE CENTRALE
ARCETO DI SCANDIANO (RE)

LUZZARA | REGGIO EMILIA | FIORANO MODENESE |
CARPI | MODENA | BOLOGNA